

**Datasheet**
**Description**

Farran Technology offers Antenna Measurement Extension Modules for extending frequency range of customer systems to 325 GHz

**Features**

- Coverage 40-325GHz
- High output power
- High dynamic range
- Low weight and compact construction
- Compatible with Agilent antenna measurement systems

**Applications**

- Near and far field antenna measurement

**Accessories**

- AC/DC converter with 2m cable
- Manual

Specification (AER-03)	Unit	Min	Typ	Max
RF Frequency In	GHz	220		325
LO Input Frequency	GHz	9.1		13.5
RF Power Input	dBm	5		10
LO Input Power	dBm	5		10
LO Harmonic Number			24	
RF in VSWR			<1.4:1	
RF Port			WR-03	
IF Frequency	MHz	5		1000
LO/IF In Port		SMA(f)		
Input LO Damage Level	dBm	15		
Minimum Detectable Signal	dBm	<100		
DC Supply		12V@0.5A		

**Datasheet**

Specification (AET-03)	Unit	Min	Typ	Max
RF Frequency Out	GHz	220		325
RF Frequency In	GHz	12.2		18.05
RF Power Out	dBm		-12	
RF Power In	dBm	5		10
LO Harmonic Number			24	
RF Out VSWR			<3.0:1	
RF In VSWR			<1.4:1	
RF Out Port			WR-03	
IF Frequency	MHz	5		1000
LO Input Frequency	GHz	9.1		13.5
RF In Port			SMA(f)	
Input LO Damage Level	dBm		15	
DC Supply			12V@1.5A	

**Antenna Measurement System with Reference Signal  
Coupled from Transmit Unit**

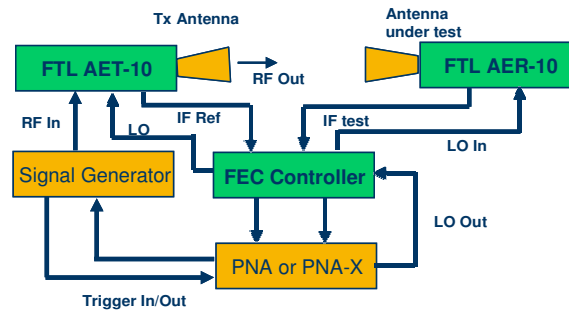

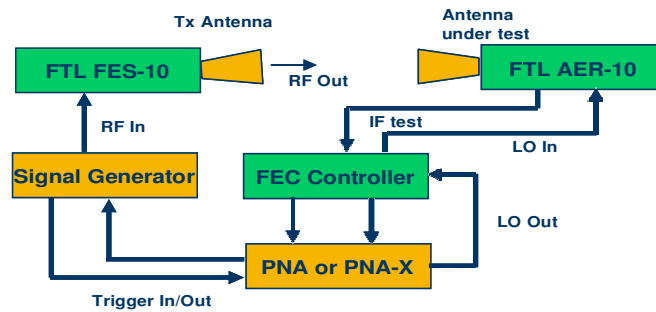
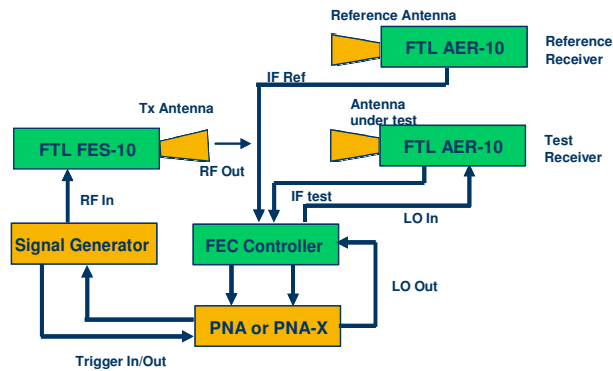
**Datasheet**
**Antenna Measurement System without Reference Signal**

**Antenna Measurement System with Reference Receiver**

**Notes:**

Farran Technology reserves the right to change, without notice, the characteristic data and other specifications applied to this product. The product may be subject to Irish export restrictions.